

OCALA 5 Drawer Tallboy

Code:22266

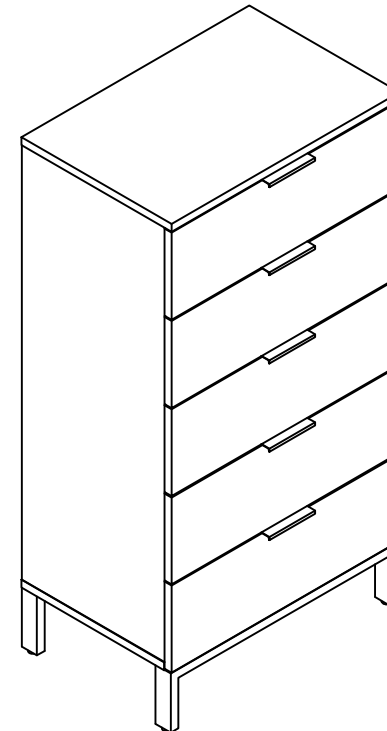

Assembly Instructions









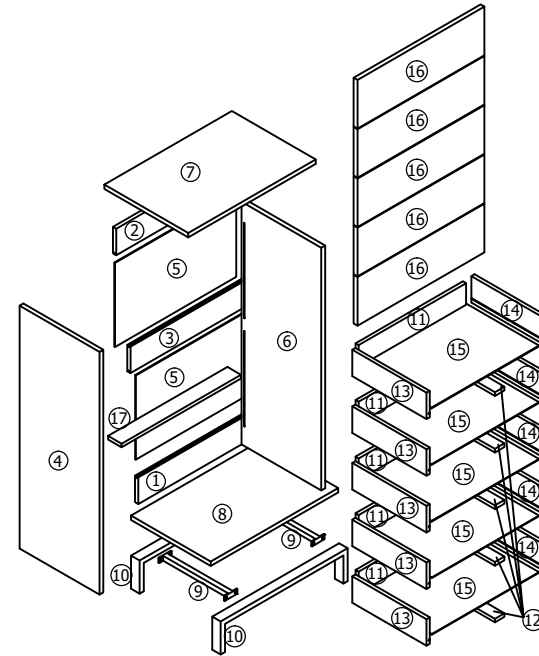
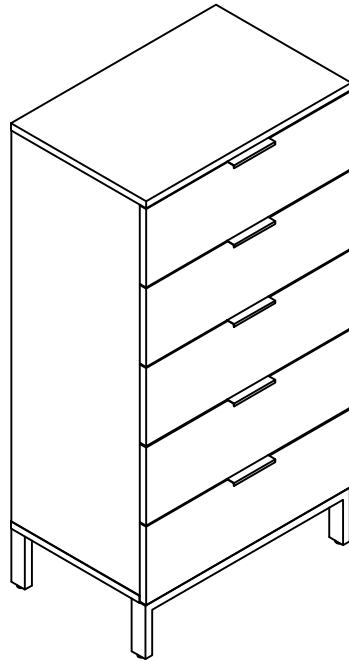

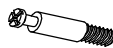

Thank you for your purchase.
please follow the instructions below for correct assembly.

- Quicker assembly, we recommend the use of a power drill on a low-speed setting
- we strongly recommend that the product is assembled on a flat and smooth surface and keep on the same horizontal line, otherwise, there will be a phenomenon of screw dislocation and cannot be installed

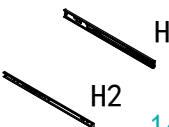
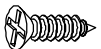
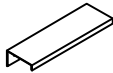

WARNING: Any furniture that is not anchored to a wall has the potential to tip over in certain circumstances, i.e. if a child attempts to climb up on the furniture or in the event of an earthquake. Accordingly, we recommend that all furniture is anchored to a wall. We supply a free safety wall anchor with all furniture sold and we recommend these are used to prevent your product tipping. See our blog here or more info on using wall anchors.

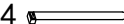

A  51set Φ 15x12mm	B  51set Φ 7x35mm	C  8pcs Φ 8x30mm	D  29pcs Φ 4x40mm	E  8pcs 6x10mm	F  1pcs 4mm	G  6pcs 6x30mm
H  5sets H1 H2 14mm	I  40pcs Φ 3.5x14mm	J  5pcs	K  10pcs Φ 3.5x14mm	L L1  43x20mm L2  Φ 4x16mm L3  Φ 7.8x38mm L4  1sets 300mm L5  Φ 4x20mm	M  4pcs Φ 20mm	

Φ : it means the diameter of the product; e.g. Φ 6 means 6mm diameter.

1

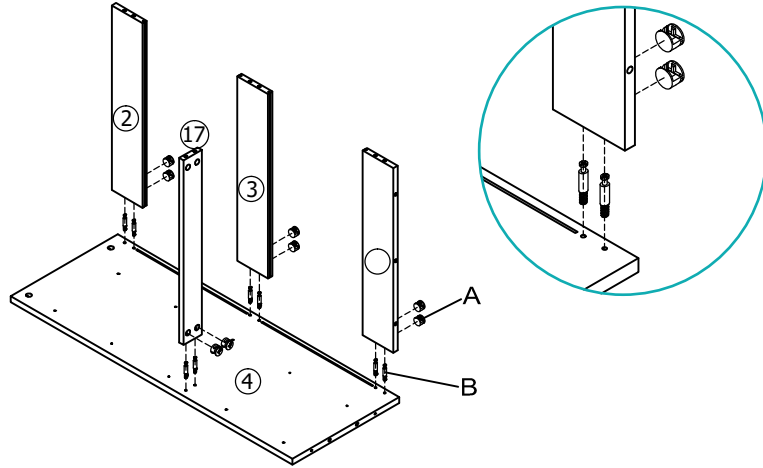

Ax8pcs Bx8pcs

2

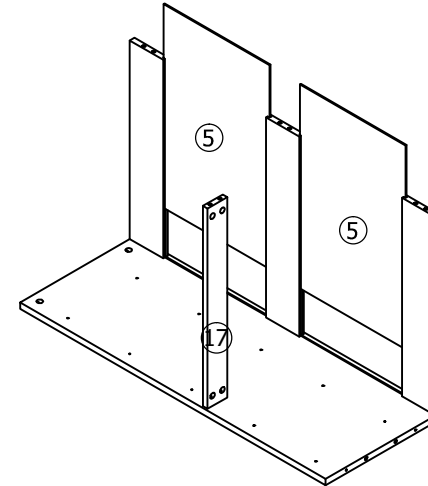

3

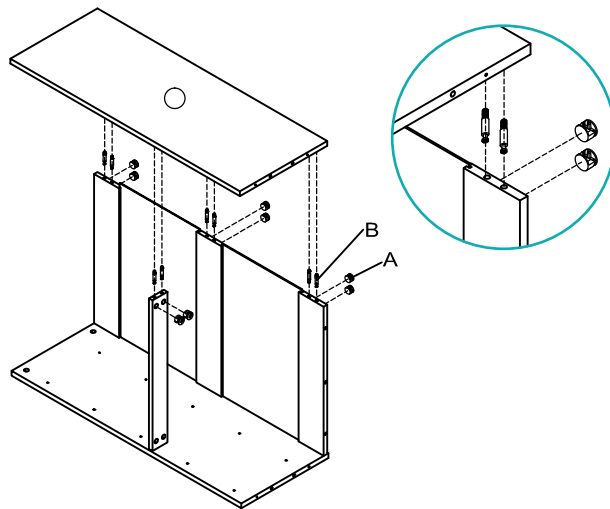

Ax8pcs Bx8pcs

4

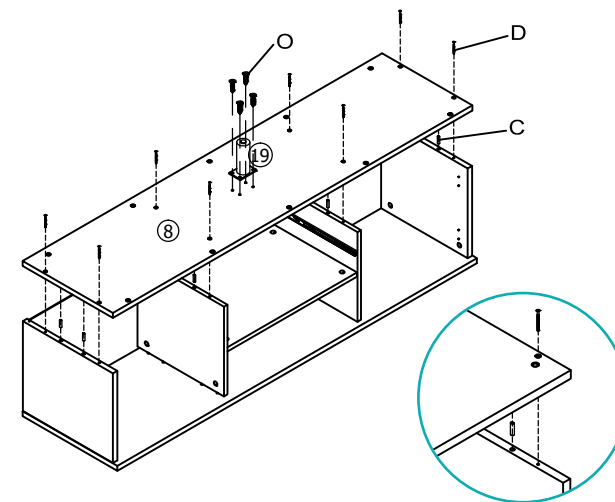

Ax10pcs Bx10pcs Cx8pcs Dx4pcs Mx4pcs

5

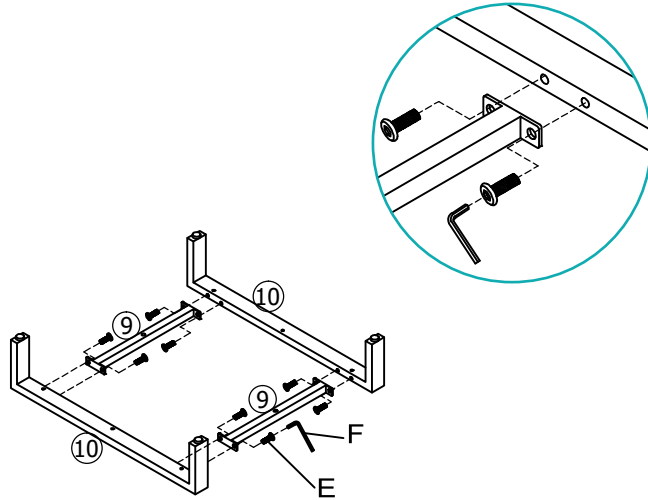

Ex8pcs

6

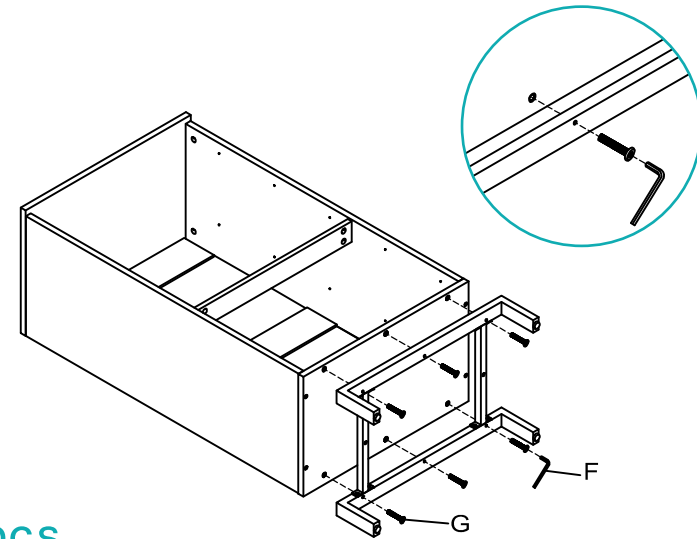

Gx6pcs

7

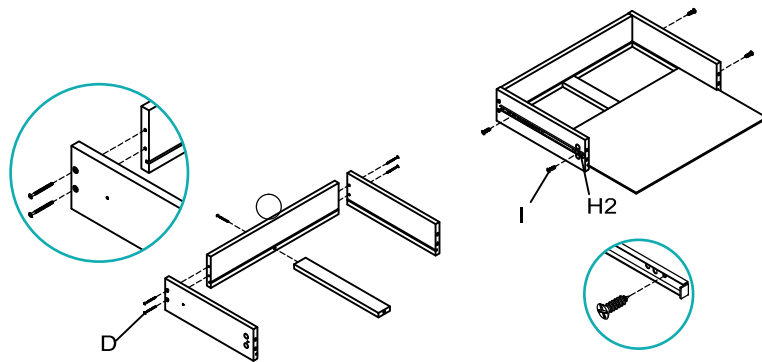

Dx25pcs H2x10pcs Ix20pcs

8

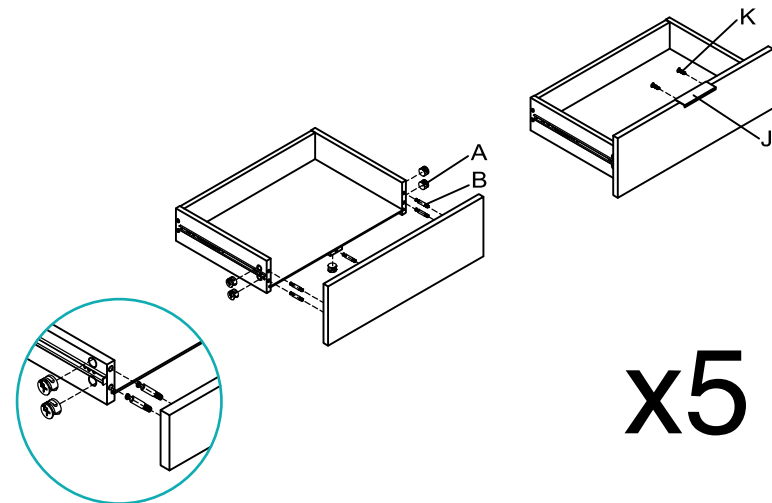

Ax25pcs Bx25pcs Jx5pcs Kx10pcs

x5

9

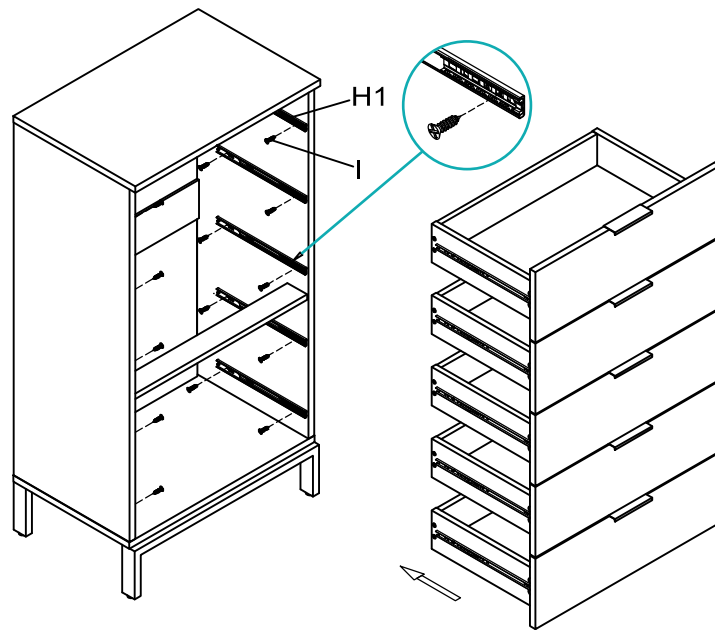

H1x10pcs Ix20pcs

10

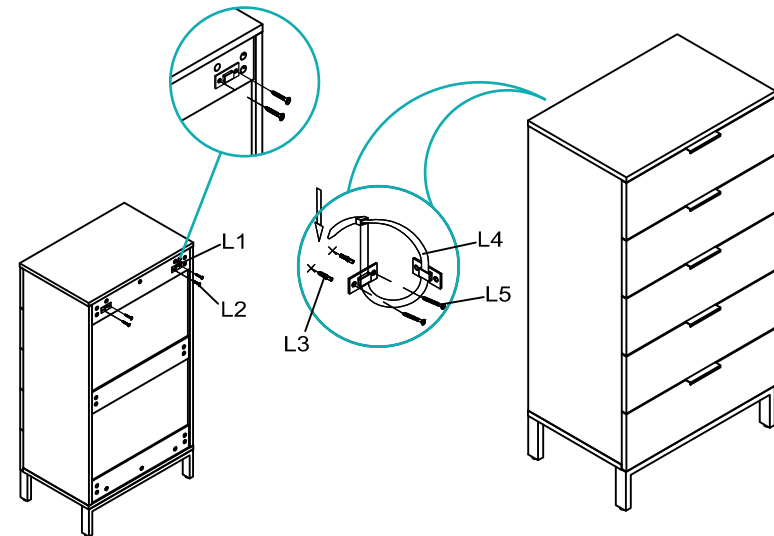

L1x4pcs L2x4pcs L3x4pcs L4x2pcs L5x4pcs

SURFACE CARE INSTRUCTIONS

A little care and attention will extend the life and good looks of your furniture. Take care when using materials which might spill, or be sharp or abrasive, on the surface of your furniture.

Normal Cleaning: For normal cleaning use a soft, dry, clean cloth. Glass Cleaning for Frosted Glass: Do not use glass cleaner of solvent based cleaner on glass that has a frosting effect on it.

Normal Glass Cleaning: You may use normal glass cleaning products on all other types of glass, Use a soft non-abrasive cloth to remove light dust and finger prints

Leather & Vinyl Cloth Cleaning: Under no circumstances should any abrasive materials be used on these surfaces, as it will result in irreparable damage.

Do not use solvents, solvent based cleaners, scouring pads, steel wool or scrubbing brushes to clean this furniture item.

Only use a slightly damp, soft, clean cloth on this surface if cleaning is needed. Do not scrub

CAUTION

- 1. When moving this furniture item, please always hold up product. Dragging or sliding could damage the product itself and the floor surface
- 2. As with all furniture, this unit should not be exposed to direct sunlight, extreme temperatures or moisture, as this can result in irreparable damage.
- 3. Be sure to protect the floor, wall or surrounding furniture with a carpet, blanket or shock-absorbing materials during assembly in order not to damage them.